

# Gear-switches

## G 50/150

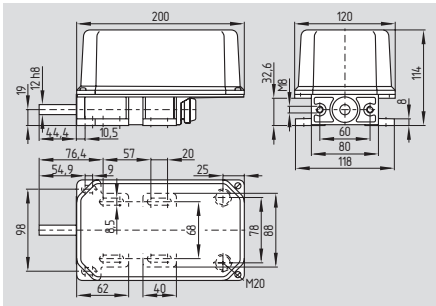

- Snap or slow action
- Metal enclosure with impact-resistant plastic hood
- Version G 50-2047, safety gear-switch for stage and studios to VBG 70
- Various cam shapes for varying switch travel
- Available for easy adjustment of switching points by setting disk cams from front
- Connecting flange available
- 2 cable entries M20 x 1.5
- Protection class IP 65

Only type G 50 is approved to VBG 70 as safety gear-switch for stages and studios, ordering suffix -2047

### Approvals



## Ordering details

G ①-②-③④⑤/③④⑤/...y-⑥

No.	Replace	Description
①	50	Transmission ratio $\leq 1:50$
	150	Transmission ratio $\geq 1:50$
②	100	Gear ratio
		For example: 1:100 Refer to selection table page 1-150
③	M	Snap action M
	Z	Snap action Z $\ominus$
	T	Slow action T $\ominus$
④	1 to 4	Number of NO (max. 4)
	1 to 4	Number of NC (max. 4)

## Technical data

Standards:	DIN VDE 0660-200 VBG 70
Enclosure:	light alloy die-casting
Cover:	polyester
Protection class:	IP 65 to EN 60529
Contact material:	silver
Rough switching point setting:	standard: 4° steps to 360° on the disk cams front setting: 3.4° steps
Fine switching point setting:	max. 0.5 turns
Gear ratio:	
G 50:	1:50, 1:35, 1:25, 1:17
G 150:	1:150, 1:75, 1:100, 1:220, 1:300, 1:450
Contact blocks:	max. 8: on T/M 697 max. 4 with cams $\varnothing 36$ mm G 50-050 and G 150-150: Z/T 6881 (otherwise additional 1:1 ratio required)
Contact type:	M 697: 1 change-over contact, T 697: 1 NC, double break, Z/T 6881: change-over contact with galvanically separated contact bridges $\ominus$
Switching system:	slow and snap action
Termination:	T/M 697: screw terminals M 3 Z/T 6881: screw terminals M 3.5
Cable section:	max. 2.5 mm <sup>2</sup> (incl. conductor ferrules)
$U_{imp}$ :	4 kV
$U_i$ :	250 V
$I_{the}$ :	T/M 697: 6 A Z/T 6881: 10 A
$I_e/U_e$ :	T/M 697: 4 A / 230 VAC Z/T 6881: 2.5 A / 230 VAC
Utilisation category:	AC-15
Max. fuse rating:	6 A gL/gG D-fuse
Switchover time:	M 697: $\leq 10$ ms Z 6881: $\leq 5$ ms
Bounce duration:	-
Ambient temperature:	- 30 °C ... + 80 °C
Mechanical life:	T/M 697: 30 million operations Z/T 6881: > 1 million operations
Switching frequency:	T/M 697: 10.000/h Z/T 6881: 3.000/h

## Note

### Range of application

Gear switches are fit for multiple applications: motorisation of theatre scenes, controlling and positioning of lifts, and platforms, gate control, etc. Depending on the contact type, they are used for switching-off or positioning movement cycles. They are geared by means of an axle.

### Operating principle

In the base models with transmission ratios of  $i = 1:50$  (G 50) or  $1:150$  (G 150), the gear revolutions are directly transmitted to the disc cam by the worm and the worm wheel, i.e. for every 50 or 150 axle revolutions, the disc cams are rotated once over 360°.

For the switching point set-up of the contacts, the central screw must be loosened. Each disc cam can be set from 4° to 4°; they all have gearing as well as a positive drive with the worm wheel. After the set-up has been carried out, the central screw must be firmly retightened.

For disc cams with front setting, "index 1600", the dowel of the disc cam must be pushed in using the screwdriver, which is located inside switch.

## Note

### Setting disk cams from front:

- Possible on all  $\varnothing 24$  mm cams
- Min. adjustment 3.4°
- Max. adjustment 360°
- Other cam combinations on request

### Do not adjust against the switch plunger!

- Max. 4 contact blocks possible with contact block Z 6881, ordering suffix Z and T 6881, ordering suffix T11
- Max. 8 contact blocks possible with contact block M 697, ordering suffix M and T 697, ordering suffix T01

# Gear-switches

## System components

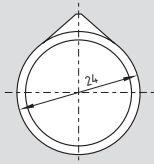

Pointed cam 24 mm Ø

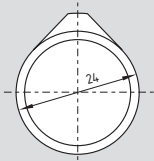

30° cam 24 mm Ø

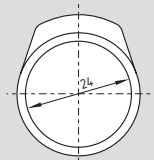

90° cam 24 mm Ø

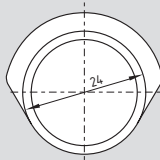

180° cam 24 mm Ø

## System components

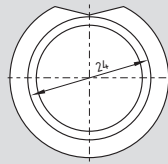

360° full cam 24 mm Ø

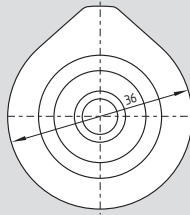

Pointed cam 36 mm Ø

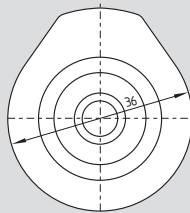

60° cam 36 mm Ø

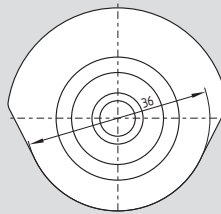

180° cam 36 mm Ø

## System components

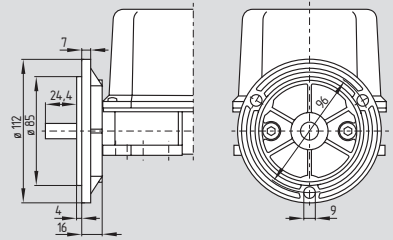

Flange FL1

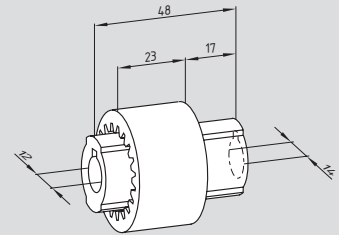

Bowex coupling

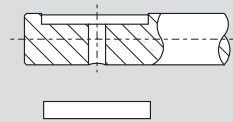

Shaft with slot and key -1368-3

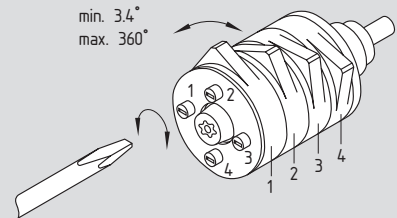

Teardrop cam with front setting -1600-1

## Ordering details

Pointed cam Ø 24 mm **ordering suffix 1600-**  
 30° cam Ø 24 mm **ordering suffix 2281-**  
 90° cam Ø 24 mm **ordering suffix 1601-**  
 180° cam Ø 24 mm **ordering suffix 2269-**  
 360° full cam Ø 24 mm **ordering suffix 1905-**

### Cam forms ø 24mm:

- Standard cam forms:  
Pointed, 30°, 90°, 180° and 360° cam
- max. 8 contact blocks possible
- Suitable for setting from front

For further details see table on page 1-150.

## Ordering details

Pointed cam Ø 36 mm **ordering suffix 1582-\***  
 60° cam Ø 36 mm **ordering suffix 1582-\***  
 180° cam Ø 36 mm **ordering suffix 1739-\***

\* Different combinations possible on request.

### Cam forms:

- Standard cam forms:  
Pointed, 60° and 180° cam
- Max. 4 contact blocks possible

## Ordering details

Flange FL1 **ordering suffix -FL1**  
 Bowex coupling with  
 shaft diameters  
 12 and 14 mm **ordering suffix -1368-2**  
 12 and 12 mm **ordering suffix -1368-4**  
 Shaft with slot  
 and key **ordering suffix -1368-3**  
 Teardrop cam with  
 front setting **ordering suffix -1600-1\***  
 (Example with 4 pointed cams)

# Gear-switches

## Cams Ø 24

Pointed cam Type/ Trans- mission ratio	Usable revolutions				Run-on revolutions				Hysteresis revolutions		Cam travel per shaft rotation	Shaft rotation with 1° cam travel	Shaft revolution		
	Switching element	M	Z	T11	T01	M	Z	T11	T01	M			Z	min.	max.
<b>G 50</b> 1:17	16.1	15.4	15.9	16.1	0.9	1.6	1.1	0.9	0.14	0.2	21.20°	17°	0.6	600	
<b>G 50</b> 1:25	23.6	22.8	23.4	23.6	1.4	2.2	1.6	1.4	0.2	0.3	14.40°	25°	0.9	600	
<b>G 50</b> 1:35	33.1	31.7	32.8	33.1	1.9	3.3	2.2	1.9	0.3	0.5	10.30°	35°	1.2	600	
<b>G 50</b> 1:50	47.3	45.3	46.8	47.3	2.7	4.7	3.2	2.7	0.4	0.7	7.20°	50°	1.7	600	
<b>G 150</b> 1:75	71.0	68.0	70.2	71.0	4.0	7.0	4.8	4.0	0.6	1.0	4.80°	75°	2.5	600	
<b>G 150</b> 1:100	94.5	90.6	93.6	94.5	5.5	9.4	6.4	5.5	0.8	1.3	3.60°	100°	3.4	600	
<b>G 150</b> 1:150	141.7	136.0	140.4	141.7	8.3	14.0	9.6	8.3	1.2	2.0	2.40°	150°	5.0	600	
<b>G 150</b> 1:220	208.0	199.4	206.0	208.0	12.0	20.6	14.0	12.0	1.8	3.0	1.64°	220°	7.3	600	
<b>G 150</b> 1:300	283.5	272.0	280.8	283.5	16.5	28.0	19.2	16.5	2.4	4.0	1.20°	300°	10.0	600	
<b>G 150</b> 1:450	425.2	407.9	421.2	425.2	24.8	42.1	28.8	24.8	3.6	6.0	0.80°	450°	15.0	600	
<b>90° cam</b>															
<b>G 50</b> 1:17	13.2	12.5	13.0	13.2	3.8	4.6	4.0	3.9	0.14	0.2	21.20°	17°	0.6	600	
<b>G 50</b> 1:25	19.4	18.4	19.2	19.4	5.6	6.7	5.9	5.8	0.2	0.3	14.40°	25°	0.9	600	
<b>G 50</b> 1:35	27.2	25.8	26.9	27.2	7.9	9.4	8.2	8.0	0.3	0.5	10.30°	35°	1.2	600	
<b>G 50</b> 1:50	38.9	36.9	38.4	38.9	11.3	13.4	11.7	11.6	0.4	0.7	7.20°	50°	1.7	600	
<b>G 150</b> 1:75	58.3	55.3	57.6	58.3	16.9	20.0	17.6	17.4	0.6	1.0	4.80°	75°	2.5	600	
<b>G 150</b> 1:100	77.7	73.8	76.8	77.7	22.6	26.8	23.5	23.2	0.8	1.3	3.60°	100°	3.4	600	
<b>G 150</b> 1:150	116.6	110.7	115.2	116.6	34.0	40.0	35.0	34.0	1.2	2.0	2.40°	150°	5.0	600	
<b>G 150</b> 1:220	171.0	162.3	169.0	171.0	50.0	59.0	52.0	51.0	1.8	3.0	1.64°	220°	7.3	600	
<b>G 150</b> 1:300	233.0	221.3	230.4	233.0	68.0	80.0	71.0	70.0	2.4	4.0	1.20°	300°	10.0	600	
<b>G 150</b> 1:450	349.7	332.0	345.6	349.7	102.0	121.0	106.0	105.0	3.6	6.0	0.80°	450°	15.0	600	
<b>180° cam</b>															
<b>G 50</b> 1:17	8.5	7.9	8.4	8.5	8.5	9.1	8.6	8.5	0.14	0.2	21.20°	17°	0.6	600	
<b>G 50</b> 1:25	12.6	11.6	12.3	12.6	12.4	13.4	12.7	12.4	0.2	0.3	14.40°	25°	0.9	600	
<b>G 50</b> 1:35	17.6	16.2	17.3	17.6	17.4	18.8	17.7	17.4	0.3	0.5	10.30°	35°	1.2	600	
<b>G 50</b> 1:50	25.1	23.2	24.7	25.1	24.9	26.8	25.3	24.9	0.4	0.7	7.20°	50°	1.7	600	
<b>G 150</b> 1:75	37.7	34.7	37.0	37.7	37.3	40.3	38.0	37.3	0.6	1.0	4.80°	75°	2.5	600	
<b>G 150</b> 1:100	50.2	46.3	49.3	50.2	49.8	53.7	50.7	49.8	0.8	1.3	3.60°	100°	3.4	600	
<b>G 150</b> 1:150	75.4	69.5	74.0	75.4	74.6	80.5	76.0	74.6	1.2	2.0	2.40°	150°	5.0	600	
<b>G 150</b> 1:220	110.5	101.9	108.5	110.5	109.5	118.1	111.5	109.5	1.8	3.0	1.64°	220°	7.3	600	
<b>G 150</b> 1:300	150.7	139.0	148.0	150.7	149.3	161.0	152.0	149.3	2.4	4.0	1.20°	300°	10.0	600	
<b>G 150</b> 1:450	226.1	208.4	221.9	226.1	223.9	241.6	228.1	223.9	3.6	6.0	0.80°	450°	15.0	600	
<b>360° cam</b>															
<b>G 50</b> 1:17	1.6	1.0	1.5	1.6	15.4	16.0	15.5	15.4	0.14	0.2	21.20°	17°	0.6	600	
<b>G 50</b> 1:25	2.4	1.5	2.2	2.4	22.6	23.5	22.8	22.6	0.2	0.3	14.40°	25°	0.9	600	
<b>G 50</b> 1:35	3.4	2.1	3.1	3.4	31.6	32.9	31.9	31.6	0.3	0.5	10.30°	35°	1.2	600	
<b>G 50</b> 1:50	4.8	3.0	4.4	4.8	45.2	47.0	45.6	45.2	0.4	0.7	7.20°	50°	1.7	600	
<b>G 150</b> 1:75	7.3	4.5	6.6	7.3	67.7	70.5	68.4	67.7	0.6	1.0	4.80°	75°	2.5	600	
<b>G 150</b> 1:100	9.7	6.0	8.8	9.7	90.3	94.0	91.2	90.3	0.8	1.3	3.60°	100°	3.4	600	
<b>G 150</b> 1:150	14.5	9.0	13.2	14.5	135.5	141.0	136.8	135.5	1.2	2.0	2.40°	150°	5.0	600	
<b>G 150</b> 1:220	21.3	13.1	19.4	21.3	198.7	206.9	200.6	198.7	1.8	3.0	1.64°	220°	7.3	600	
<b>G 150</b> 1:300	29.0	17.9	26.5	29.0	271.0	282.1	273.5	271.0	2.4	4.0	1.20°	300°	10.0	600	
<b>G 150</b> 1:450	43.5	26.9	39.7	43.5	406.5	423.1	410.3	406.5	3.6	6.0	0.80°	450°	15.0	600	